

NPN - MPS650, MPS651; PNP - MPS750, MPS751

MPS651 and MPS751 are Preferred Devices

Amplifier Transistors

Features

- Pb-Free Packages are Available*

MAXIMUM RATINGS

Rating	Symbol	Value	Unit
Collector-Emitter Voltage MPS650; MPS750 MPS651; MPS751	V_{CE}	40 60	Vdc
Collector-Base Voltage MPS650; MPS750 MPS651; MPS751	V_{CB}	60 80	Vdc
Emitter-Base Voltage	V_{EB}	5.0	Vdc
Collector Current - Continuous	I_C	2.0	Adc
Total Power Dissipation @ $T_A = 25^\circ\text{C}$ Derate above 25°C	P_D	625 5.0	mW mW/ $^\circ\text{C}$
Total Power Dissipation @ $T_C = 25^\circ\text{C}$ Derate above 25°C	P_D	1.5 12	W mW/ $^\circ\text{C}$
Operating and Storage Junction Temperature Range	T_J, T_{stg}	-55 to +150	$^\circ\text{C}$

THERMAL CHARACTERISTICS

Characteristic	Symbol	Max	Unit
Thermal Resistance, Junction-to-Ambient	V_{CE}	200	$^\circ\text{C}/\text{W}$
Thermal Resistance, Junction-to-Case	V_{CB}	83.3	$^\circ\text{C}/\text{W}$

Stresses exceeding Maximum Ratings may damage the device. Maximum Ratings are stress ratings only. Functional operation above the Recommended Operating Conditions is not implied. Extended exposure to stresses above the Recommended Operating Conditions may affect device reliability.

*For additional information on our Pb-Free strategy and soldering details, please download the ON Semiconductor Soldering and Mounting Techniques Reference Manual, SOLDERRM/D.



ON Semiconductor®

<http://onsemi.com>

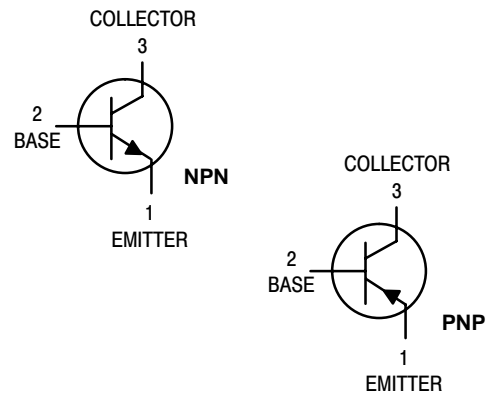

TO-92
CASE 29
STYLE 1

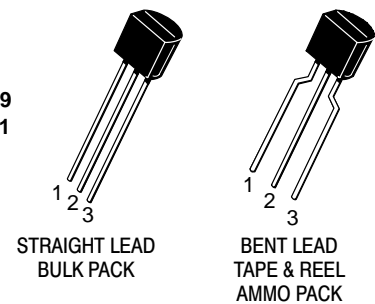

STRAIGHT LEAD
BULK PACK

BENT LEAD
TAPE & REEL
AMMO PACK

MARKING DIAGRAM

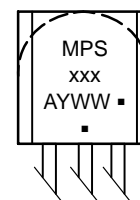

xxx = 650, 750, 651, or 751
A = Assembly Location
Y = Year
WW = Work Week
▪ = Pb-Free Package

(Note: Microdot may be in either location)

ORDERING INFORMATION

See detailed ordering and shipping information in the package dimensions section on page 4 of this data sheet.

Preferred devices are recommended choices for future use and best overall value.

NPN – MPS650, MPS651; PNP – MPS750, MPS751

ELECTRICAL CHARACTERISTICS (T_C = 25°C unless otherwise noted)

Characteristic		Symbol	Min	Max	Unit
OFF CHARACTERISTICS					
Collector–Emitter Breakdown Voltage (Note 1) (I _C = 10 mA, I _B = 0)	MPS650, MPS750 MPS651, MPS751	V _{(BR)CEO}	40 60	– –	Vdc
Collector–Base Breakdown Voltage (I _C = 100 μA, I _E = 0)	MPS650, MPS750 MPS651, MPS751	V _{(BR)CBO}	60 80	– –	Vdc
Emitter–Base Breakdown Voltage (I _C = 0, I _E = 10 μA)		V _{(BR)EBO}	5.0	–	Vdc
Collector Cutoff Current (V _{CB} = 60 Vdc, I _E = 0) (V _{CB} = 80 Vdc, I _E = 0)	MPS650, MPS750 MPS651, MPS751	I _{CBO}	– –	0.1 0.1	μA
Emitter Cutoff Current (V _{EB} = 4.0 V, I _C = 0)		I _{EBO}	–	0.1	μA

ON CHARACTERISTICS (Note 1)

DC Current Gain (I _C = 50 mA, V _{CE} = 2.0 V) (I _C = 500 mA, V _{CE} = 2.0 V) (I _C = 1.0 A, V _{CE} = 2.0 V) (I _C = 2.0 A, V _{CE} = 2.0 V)		h _{FE}	75 75 75 40	– – – –	–
Collector–Emitter Saturation Voltage (I _C = 2.0 A, I _B = 200 mA) (I _C = 1.0 A, I _B = 100 mA)		V _{CE(sat)}	– –	0.5 0.3	Vdc
Base–Emitter On Voltage (I _C = 1.0 A, V _{CE} = 2.0 V)		V _{BE(on)}	–	1.0	Vdc
Base–Emitter Saturation Voltage (I _C = 1.0 A, I _B = 100 mA)		V _{BE(sat)}	–	1.2	Vdc

SMALL–SIGNAL CHARACTERISTICS

Current–Gain – Bandwidth Product (Note 2) (I _C = 50 mA, V _{CE} = 5.0 Vdc, f = 100 MHz)		f _T	75	–	MHz
---	--	----------------	----	---	-----

1. Pulse Test: Pulse Width ≤ 300 μs, Duty Cycle = 2.0%.
2. f_T is defined as the frequency at which |h_{fe}| extrapolates to unity.

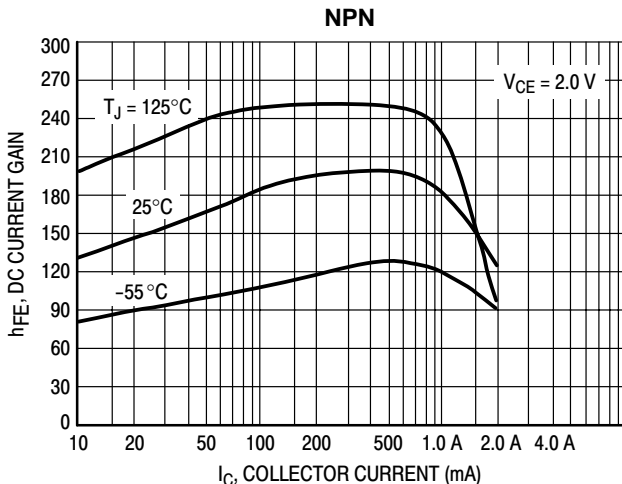

**Figure 1. MPS650, MPS651
Typical DC Current Gain**

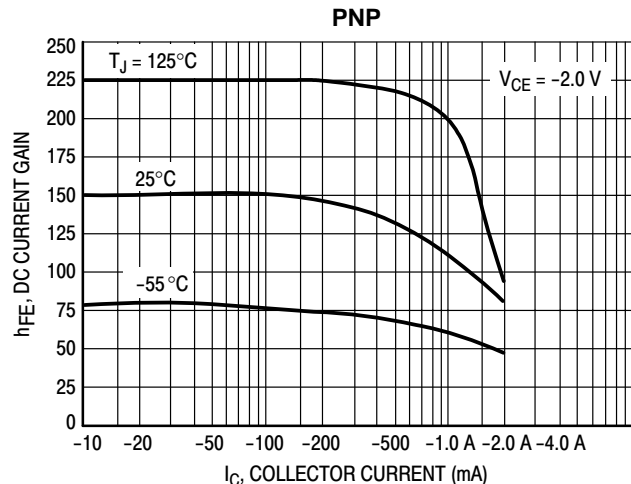

**Figure 2. MPS750, MPS751
Typical DC Current Gain**

NPN – MPS650, MPS651; PNP – MPS750, MPS751

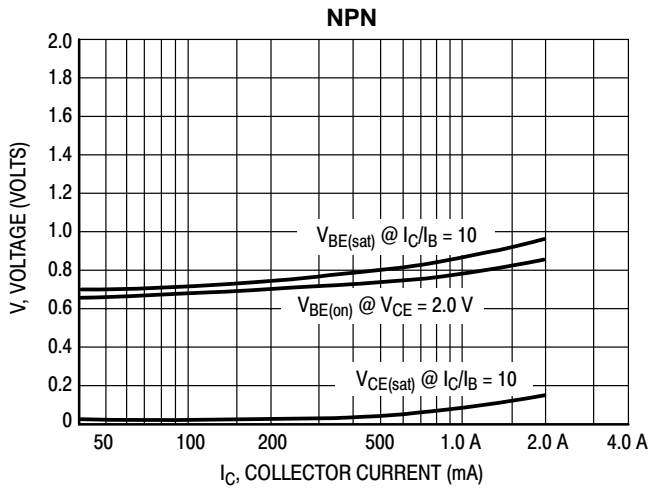

Figure 3. MPS650, MPS651
On Voltages

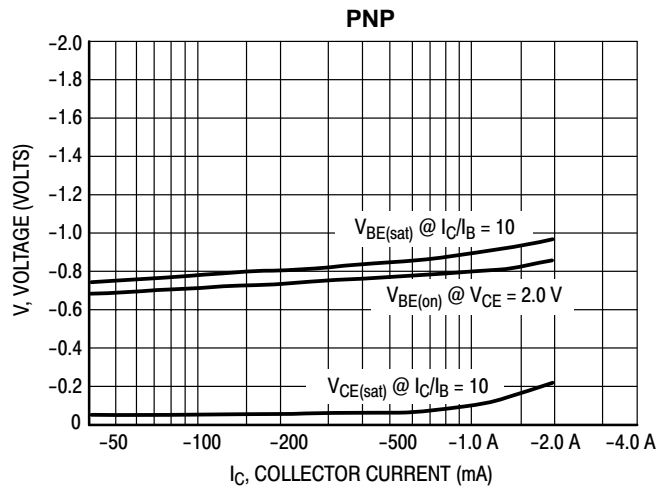

Figure 4. MPS750, MPS751
On Voltages

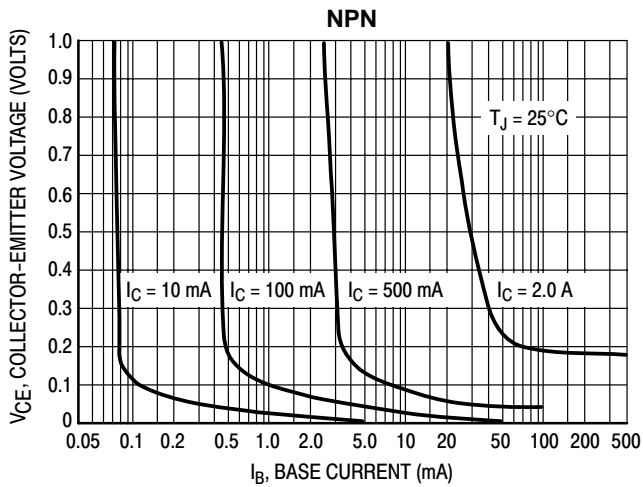

Figure 5. MPS650, MPS651
Collector Saturation Region

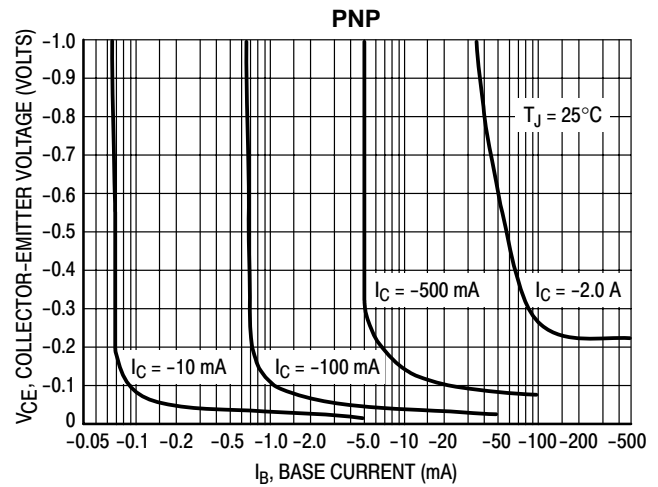

Figure 6. MPS750, MPS751
Collector Saturation Region

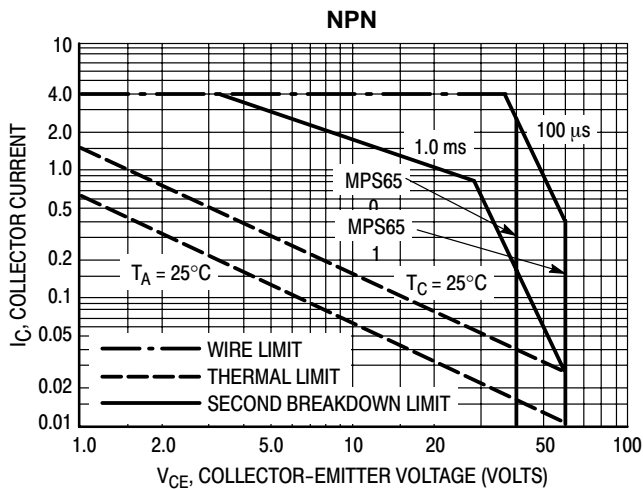

Figure 7. MPS650, MPS651 SOA,
Safe Operating Area

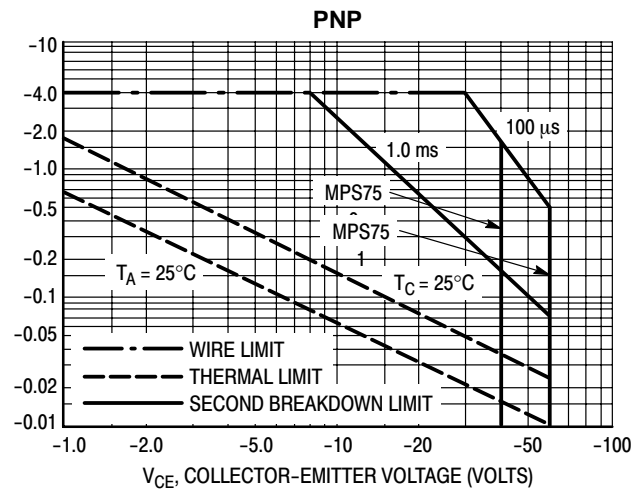

Figure 8. MPS750, MPS751 SOA,
Safe Operating Area

NPN – MPS650, MPS651; PNP – MPS750, MPS751

ORDERING INFORMATION

Device	Package	Shipping†
MPS650	TO-92	5000 Units / Bulk
MPS650G	TO-92 (Pb-Free)	5000 Units / Bulk
MPS650RLRAG	TO-92 (Pb-Free)	2000 / Tape & Reel
MPS650ZL1G	TO-92 (Pb-Free)	2000 / Tape & Ammunition
MPS651	TO-92	5000 Units / Bulk
MPS651G	TO-92 (Pb-Free)	5000 Units / Bulk
MPS651RLRAG	TO-92 (Pb-Free)	2000 / Tape & Reel
MPS651RLRM	TO-92	2000 / Tape & Ammunition
MPS651RLRMG	TO-92 (Pb-Free)	2000 / Tape & Ammunition
MPS750G	TO-92 (Pb-Free)	5000 Units / Bulk
MPS750RLRAG	TO-92 (Pb-Free)	2000 / Tape & Reel
MPS750RLRP	TO-92	2000 / Tape & Ammunition
MPS750RLRPG	TO-92 (Pb-Free)	2000 / Tape & Ammunition
MPS751	TO-92	5000 Units / Bulk
MPS751G	TO-92 (Pb-Free)	5000 Units / Bulk
MPS751RLRA	TO-92	2000 / Tape & Reel
MPS751RLRAG	TO-92 (Pb-Free)	2000 / Tape & Reel
MPS751RLRP	TO-92	2000 / Tape & Ammunition
MPS751RLRPG	TO-92 (Pb-Free)	2000 / Tape & Ammunition
MPS751ZL1G	TO-92 (Pb-Free)	2000 / Tape & Ammunition

†For information on tape and reel specifications, including part orientation and tape sizes, please refer to our Tape and Reel Packaging Specifications Brochure, BRD8011/D.

NPN – MPS650, MPS651; PNP – MPS750, MPS751

PACKAGE DIMENSIONS

TO-92 (TO-226)
CASE 29-11
ISSUE AM

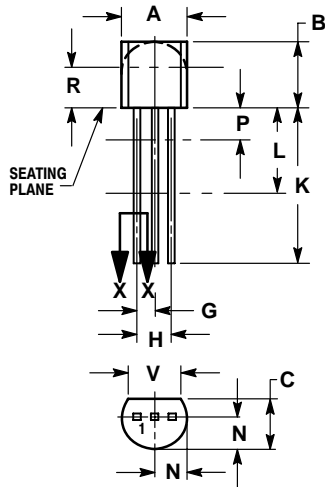

STRAIGHT LEAD
BULK PACK

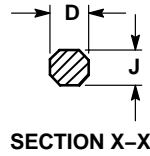

SECTION X-X

NOTES:

1. DIMENSIONING AND TOLERANCING PER ANSI Y14.5M, 1982.
2. CONTROLLING DIMENSION: INCH.
3. CONTOUR OF PACKAGE BEYOND DIMENSION R IS UNCONTROLLED.
4. LEAD DIMENSION IS UNCONTROLLED IN P AND BEYOND DIMENSION K MINIMUM.

DIM	INCHES		MILLIMETERS	
	MIN	MAX	MIN	MAX
A	0.175	0.205	4.45	5.20
B	0.170	0.210	4.32	5.33
C	0.125	0.165	3.18	4.19
D	0.016	0.021	0.407	0.533
G	0.045	0.055	1.15	1.39
H	0.095	0.105	2.42	2.66
J	0.015	0.020	0.39	0.50
K	0.500	---	12.70	---
L	0.250	---	6.35	---
N	0.080	0.105	2.04	2.66
P	---	0.100	---	2.54
R	0.115	---	2.93	---
V	0.135	---	3.43	---

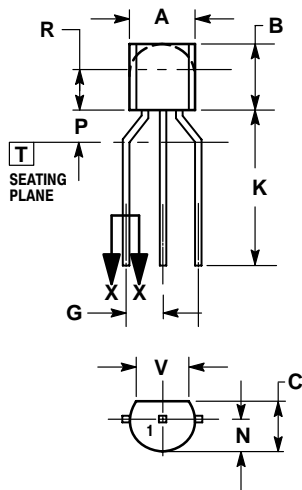

BENT LEAD
TAPE & REEL
AMMO PACK

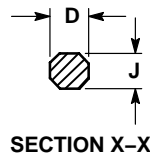

SECTION X-X

NOTES:

1. DIMENSIONING AND TOLERANCING PER ASME Y14.5M, 1994.
2. CONTROLLING DIMENSION: MILLIMETERS.
3. CONTOUR OF PACKAGE BEYOND DIMENSION R IS UNCONTROLLED.
4. LEAD DIMENSION IS UNCONTROLLED IN P AND BEYOND DIMENSION K MINIMUM.

DIM	MILLIMETERS	
	MIN	MAX
A	4.45	5.20
B	4.32	5.33
C	3.18	4.19
D	0.40	0.54
G	2.40	2.80
J	0.39	0.50
K	12.70	---
N	2.04	2.66
P	1.50	4.00
R	2.93	---
V	3.43	---

STYLE 1:

1. EMITTER
2. BASE
3. COLLECTOR

ON Semiconductor and are registered trademarks of Semiconductor Components Industries, LLC (SCILLC). SCILLC reserves the right to make changes without further notice to any products herein. SCILLC makes no warranty, representation or guarantee regarding the suitability of its products for any particular purpose, nor does SCILLC assume any liability arising out of the application or use of any product or circuit, and specifically disclaims any and all liability, including without limitation special, consequential or incidental damages. "Typical" parameters which may be provided in SCILLC data sheets and/or specifications can and do vary in different applications and actual performance may vary over time. All operating parameters, including "Typicals" must be validated for each customer application by customer's technical experts. SCILLC does not convey any license under its patent rights nor the rights of others. SCILLC products are not designed, intended, or authorized for use as components in systems intended for surgical implant into the body, or other applications intended to support or sustain life, or for any other application in which the failure of the SCILLC product could create a situation where personal injury or death may occur. Should Buyer purchase or use SCILLC products for any such unintended or unauthorized application, Buyer shall indemnify and hold SCILLC and its officers, employees, subsidiaries, affiliates, and distributors harmless against all claims, costs, damages, and expenses, and reasonable attorney fees arising out of, directly or indirectly, any claim of personal injury or death associated with such unintended or unauthorized use, even if such claim alleges that SCILLC was negligent regarding the design or manufacture of the part. SCILLC is an Equal Opportunity/Affirmative Action Employer. This literature is subject to all applicable copyright laws and is not for resale in any manner.

PUBLICATION ORDERING INFORMATION

LITERATURE FULFILLMENT:
Literature Distribution Center for ON Semiconductor
P.O. Box 5163, Denver, Colorado 80217 USA
Phone: 303-675-2175 or 800-344-3860 Toll Free USA/Canada
Fax: 303-675-2176 or 800-344-3867 Toll Free USA/Canada
Email: orderlit@onsemi.com

N. American Technical Support: 800-282-9855 Toll Free
USA/Canada
Europe, Middle East and Africa Technical Support:
Phone: 421 33 790 2910
Japan Customer Focus Center
Phone: 81-3-5773-3850

ON Semiconductor Website: www.onsemi.com
Order Literature: <http://www.onsemi.com/orderlit>

For additional information, please contact your local Sales Representative